

Item No: _____

Model No: _____

Qty: _____

Project: _____

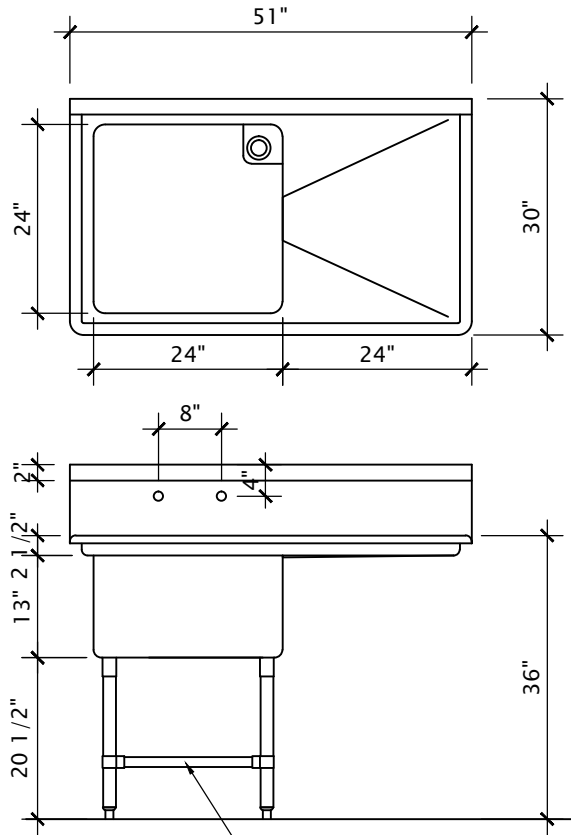

3 Sided Leg Brace

Sizes nominal, subject to change without notice.

CORNER Drain Sinks

- Heavy duty stainless steel construction
- 13" deep bowls
- "All-Coved" corner construction
- 1.5 inch diameter radius bullnose
- Overflow tube and drain included
- 4 inch x 4 inch x 8 inch high perforated drain guard assembly included
- Galvanized legs, 1 5/8" in diameter
- 3 sided leg brace included
- Adjustable bullet feet
- Faucet holes on 8 inch centres (faucets not included)
- Shipped knock down
- Fully welded available if required

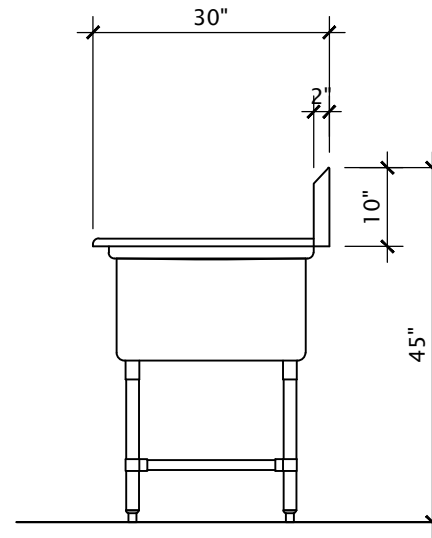

CDS1-24R



C US
U.P. Code

ASME A112.19.3/CSA B45.4

Tarrison Products Ltd.

Corporate Head Office
2780 Coventry Road,
Oakville, Ontario, L6H 6R1
Phone: 905-825-9665
Fax: 905-825-0965
info@tarrison.com
www.tarrison.com

US Distribution Center
150 Gratiot Blvd,
Marysville, MI 48040
info@tarrison.com
www.tarrison.com

US Sales Office
29 Craftsbury Crest,
Essex Junction, VT. 05452
Phone: 802-872-9292
info@tarrison.com
www.tarrison.com